

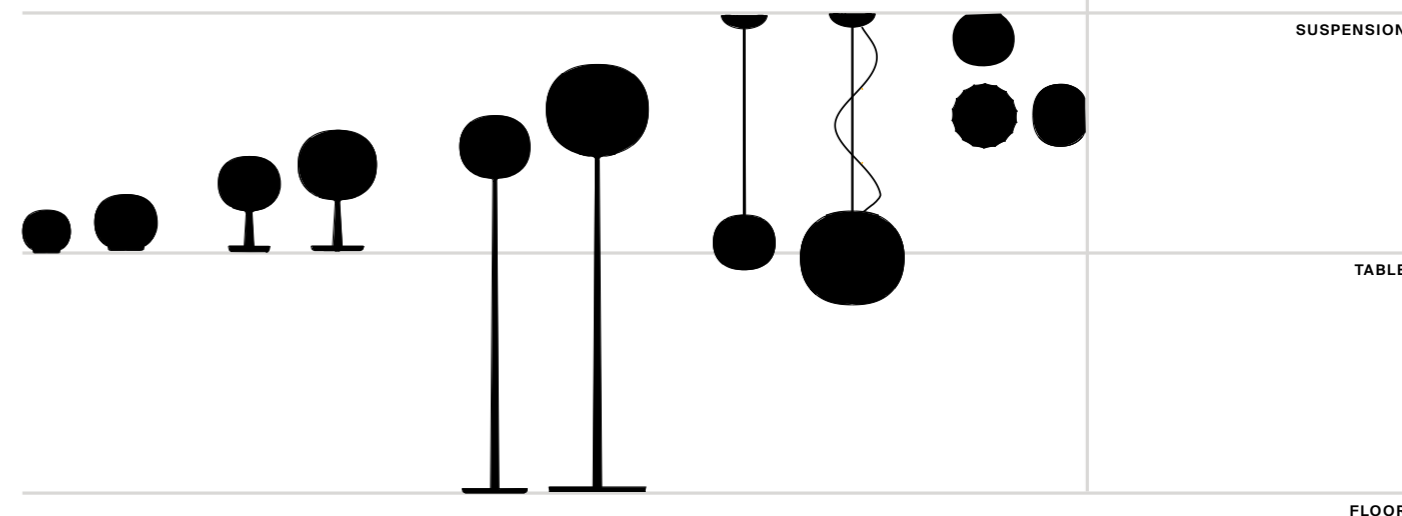

# Lita



David Dolcini, 2018

**EN** Lita by David Dolcini is an extremely versatile family of decorative lamps, the result of a delicate design process that mixes imagery, signs, geometric textures and natural materials. The result is a collection with its own elegant simplicity, including table, floor, suspension and wall/ceiling solutions. The diffuser in opaline blown glass – whose surface is scanned by the repetition of slight vertical cusps that vanish at the extremities – is combined with a wooden structure, making Lita a product with a forceful material character. A timeless and evocative object that combines the crafts tradition with technical research, seductive in its way of matching visual and tactile sensations.

**IT** Lita di David Dolcini è una famiglia di lampade decorative estremamente versatile, frutto di un delicato processo progettuale che mescola iconografie, segni, texture geometriche e materiali naturali. Ne risulta una collezione dall'elegante semplicità che comprende soluzioni da tavolo, terra, sospensione, parete/plafone. Il diffusore in vetro soffiato opalino – la cui superficie è scandita dalla ripetizione di lievi cuspidi verticali che svaniscono ai poli – si sposa con la struttura in legno, rendendo Lita un prodotto dalla forte componente materica. Un oggetto atemporale ed evocativo che unisce tradizione artigianale e ricerca tecnica, incantando per la consonanza tra percezioni visive e tattili.

**DE** Lita von David Dolcini ist eine extrem vielseitige dekorative Leuchtenfamilie, entstanden in sensibler Entwurfsarbeit, die Ikonographien, Zeichen, geometrische Texturen und natürliche Materialien gekonnt mixt. Das Ergebnis ist eine Kollektion aus Tisch-, Steh-, Pendel- und Wandleuchten von eleganter Schlichtheit. Der Diffusor aus geblasenem Opalglas mit einer schwach gerippten, nach oben und unten hin glatt verlaufenden Oberfläche ist mit Holz kombiniert, wodurch Lita einen kraftvollen materiellen Charakter erhält. Sie wirkt zeitlos und evokativ, verbindet handwerkliche Tradition mit technischem Gehalt und fasziniert durch das Zusammenspiel ihres optischen und taktilen Eindrucks.

**FR** Lita de David Dolcini est une famille de lampes décoratives extrêmement polyvalente, fruit d'un processus de conception délicat qui mélange des iconographies, des signes, des textures géométriques et des matériaux naturels. Le résultat est une collection d'une simplicité élégante, qui comprend des solutions de table, de sol, des suspensions, appliques et plafonniers. Le diffuseur en verre soufflé opalin, dont la surface est balayée par la répétition de légères cuspidés verticales qui disparaissent aux extrémités, est associé à la structure en bois, faisant de Lita un produit à forte composante matérielle. Un objet intemporel et évocateur qui allie la tradition artisanale à la recherche technique, séduisant par sa manière de faire correspondre les sensations visuelles et tactiles.

**ES** Lita de David Dolcini es una familia de lámparas decorativas sumamente versátil, fruto de un delicado proceso de proyecto que mezcla iconografías, signos, texturas geométricas y materiales naturales. El resultado es una colección con una elegante simplicidad que incluye soluciones de mesa, suelo, suspensión y pared/plafón. El difusor de vidrio soplado opalino – cuya superficie la marca la repetición de suaves cumbres verticales que se desvanecen en los polos – casa con la estructura de madera, convirtiendo a Lita en un producto con un fuerte componente material. Un objeto intemporal y evocativo que conjuga tradición artesanal e investigación técnica que cautiva por la afinidad de percepciones visuales y táctiles.



SUSPENSION

TABLE

FLOOR

WALL

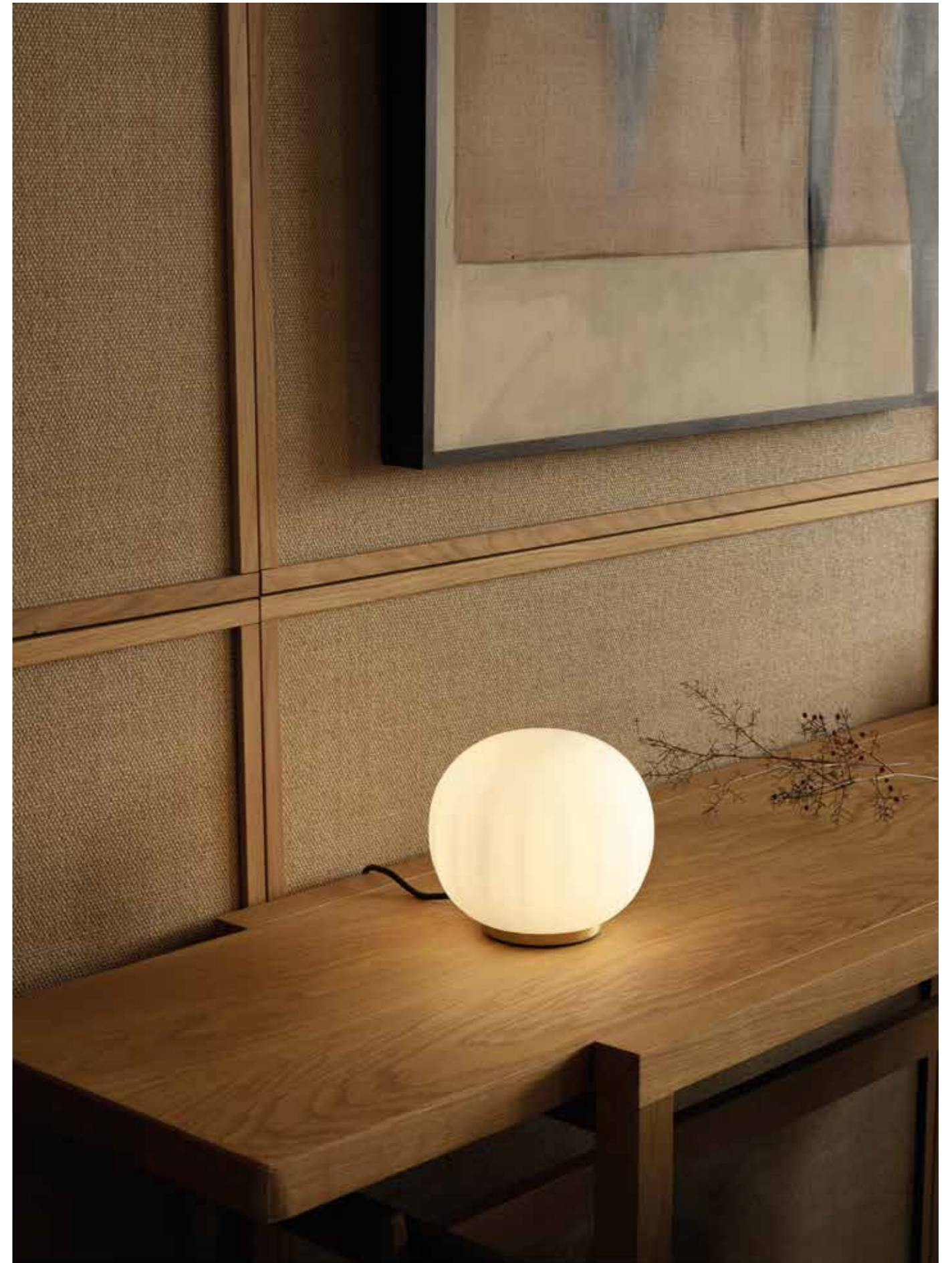





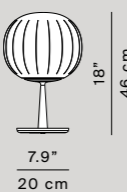
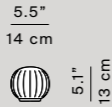
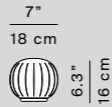
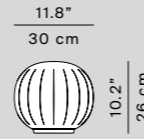

TECHNICAL DATA

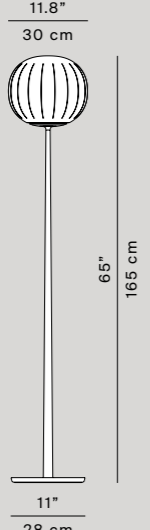
<b>D92 table</b> dimmer on board	<b>D92=18 + D92/2</b> 	<b>D92=30 + D92/3</b> 	<b>D92V14 on/off switch</b> 	<b>D92V18 + D92/2</b> 	<b>D92V30 + D92/3</b> 
-------------------------------------	--	--	--	---	--

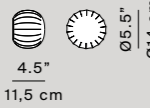
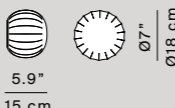
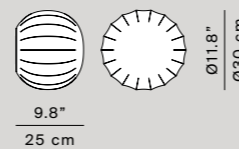

<b>D92 floor</b> dimmer on board	<b>D92T30 + D92/3</b> 	<b>D92T42 + D92/4</b> 
-------------------------------------	---	---

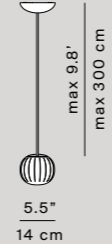
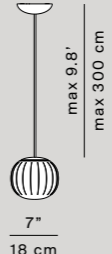
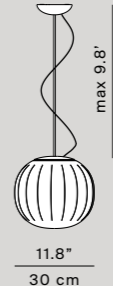
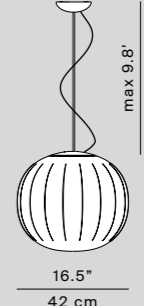

<b>D92 ceiling/wall</b> dimmmable	<b>D92P14</b> 	<b>D92P18 + D92/2</b> 	<b>D92P30 + D92/3</b> 
--------------------------------------	--	--	--

MOD. Lita

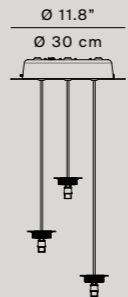
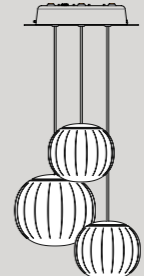
LUCEPLAN 2021/22

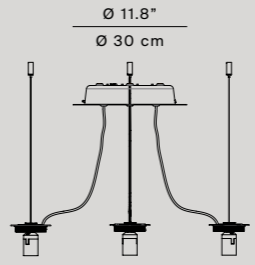
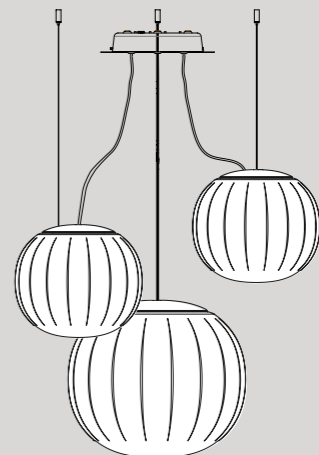

<b>D92 suspension</b> dimmmable	<b>D92S14</b> 	<b>D92S18 + D92/2</b> 	<b>D92S30 + D92/3</b> 	<b>D92S42 + D92/4</b> 
------------------------------------	--	--	--	--

<b>D92/7</b> multiple ceiling rose for diffusers Ø 14 or 18 cm L cable 5 m		<b>possible configuration</b> 
ceiling rose Ø 30 x 5,6 cm		

<b>D92/8</b> multiple ceiling rose for diffusers Ø 30 or 42 cm L cable 5 m		<b>possible configuration</b> 
ceiling rose Ø 30 x 5,6 cm		

<b>Light source</b>	<b>D92V14 - D92=18 - D92V18</b> <b>D92P14 - D92P18</b> <b>D92S14 - D92S18</b>	LED G9 dimmmable
	<b>D92=30 - D92V30</b> <b>D92T30 - D92T42</b> <b>D92P30 - D92S30 - D92S42</b>	LED E27 dimmmable

**Materials** Solid ash wood or painted aluminium structure, blown opal glass diffuser

<b>Structure finishes</b>	 Matt white	 Ash wood	 Brass
---------------------------	--	--	---

<b>Diffuser finishes</b>	 Satin opal
--------------------------	--



TECHNICAL DATA

MOD. Lita

LUCEPLAN 2021/22